

Microcontroller (Brain)

Board ID Pins

Buttons

Temperature Sensor

Light Sensor

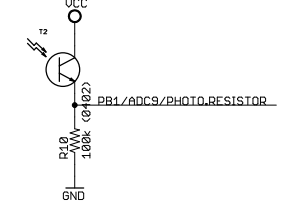
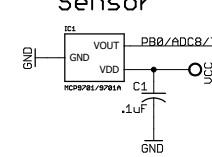
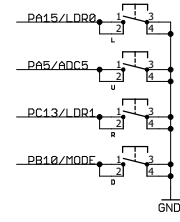
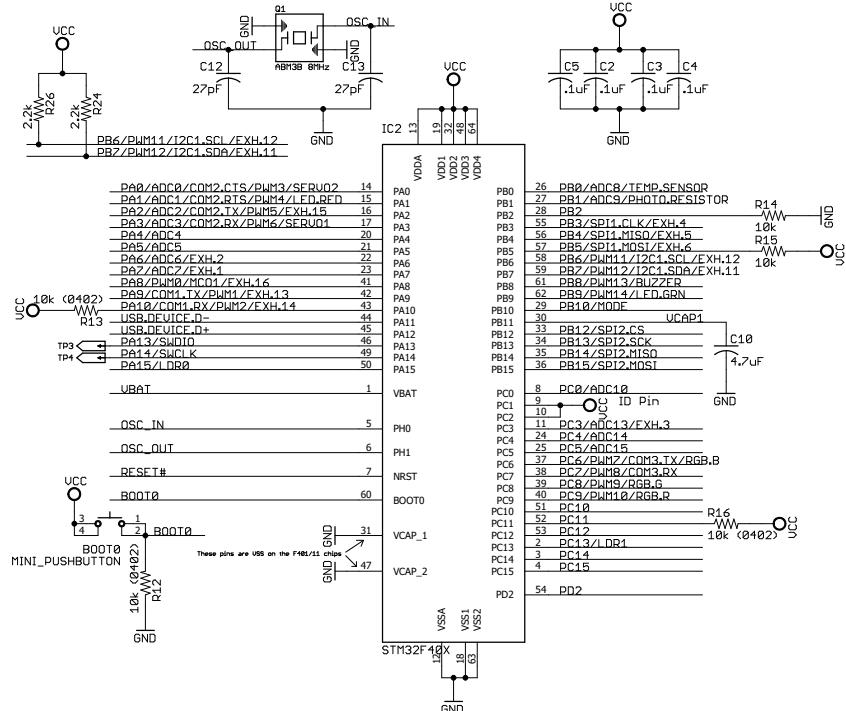

Servo Motors

Accelerometer

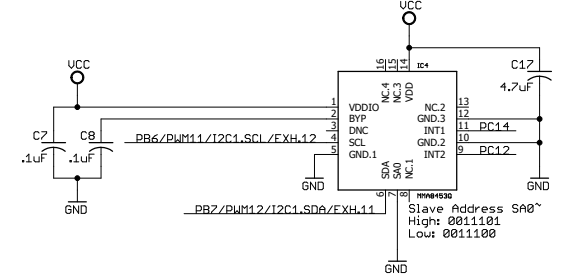
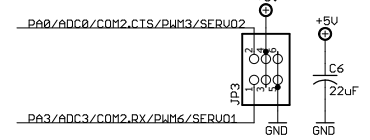

Multi-colored LED (Bulb)

Expansion Headers

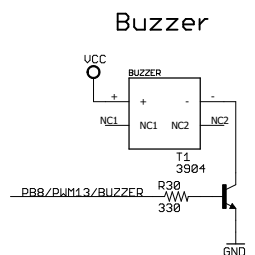
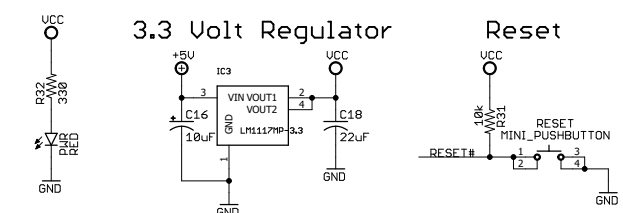

US1			
1	AN	16	PB8/PWM10/MCO1/EXH.16
2	RST	15	PA2/ADC2/COM2.TX/PWM5/EXH.15
3	CS	14	PA10/COM1.RX/PWM2/EXH.14
4	SKK	13	PA9/COM1.TX/PWM1/EXH.13
5	MISO	12	PB6/PWM11/12C1.SCL/EXH.12
6	MOSI	11	PB7/PWM12/12C1.SDA/EXH.11
7	3V3	10	SV
8	GND1	9	GND2

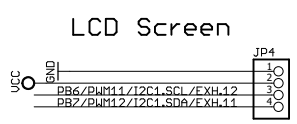
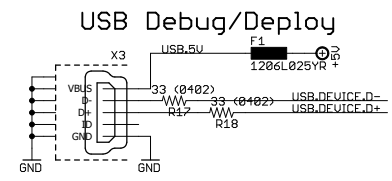

electronics **www.BrainPad.com**

TITLE: BrainPad BP2

Document Number: REV:

Date: 7/31/2017 3:24 PM Sheet: 1/1

